



sprocket 08B-3 10 teeth

Part no.: 81001116

Packaging Unit: 1pce

Model: 10 teeth

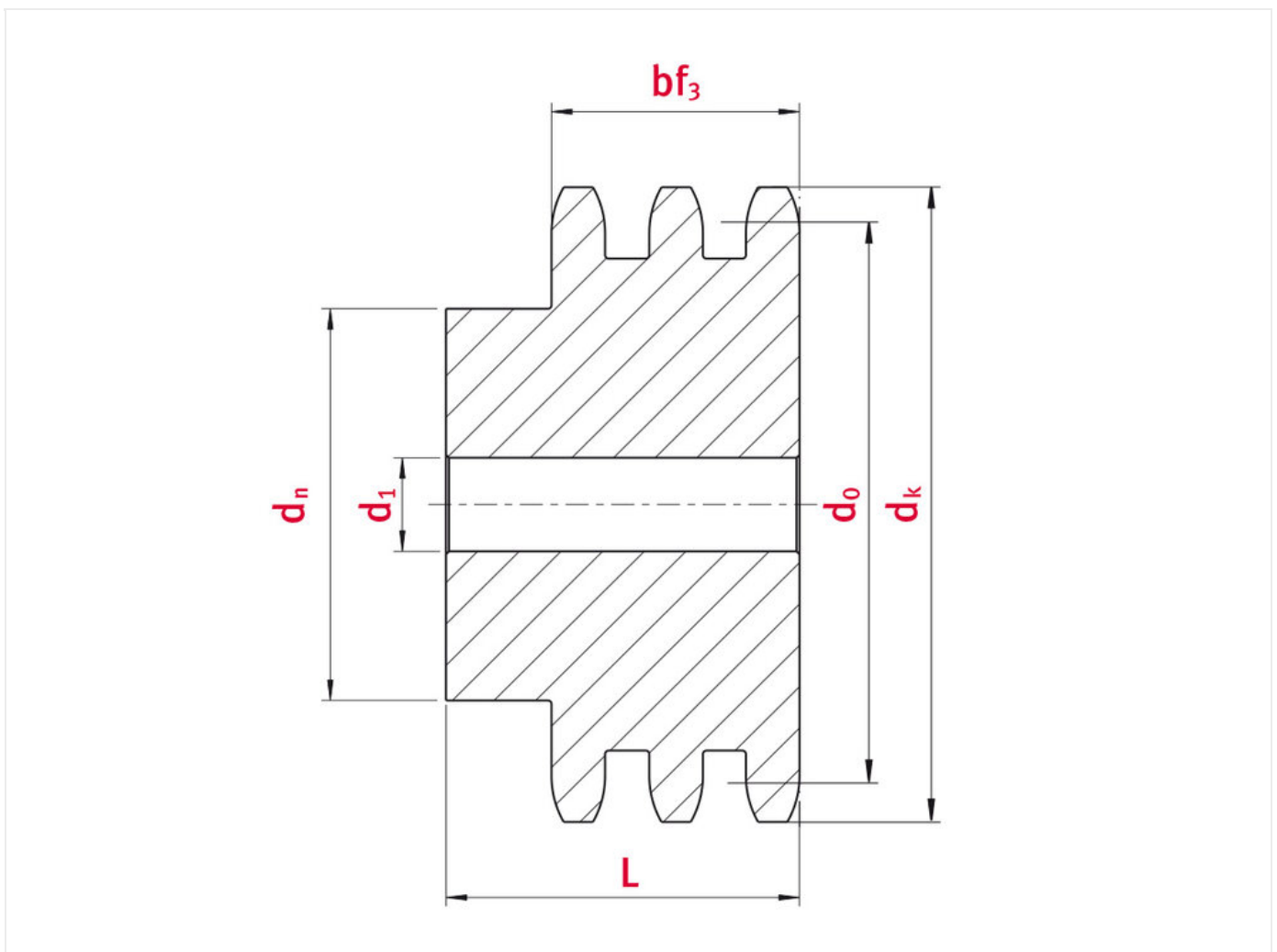

Technical data

SPROCKET	08B
Pitch p (mm)	12,7
Width between inner plates b1 min. (mm)	7,75
Roller diameter d1 max. (mm)	8,51

Teeth	10
Tip circle dk (mm)	45,2
Pilot bore d1 (mm)	12
Total length L (mm)	46
Hub	28

Product Information

iwis offers in the "plate wheels and drive components" sector an impressively wide range and broad stock of various plate wheels with pilot bores, and has full machining facilities in order to rapidly rework pilot bore plate wheels to customers demands. Furthermore, iwis provides fully finished plate wheels manufactured according to customer designs and drawings. iwis can always supply a wide range of ISO 606-compliant standard sprockets and plate wheels from stock. Our standard range covers sprockets and plate wheels in sizes 05 B-1 to 32 B-3.

Highlights:

- All sprockets are suitable for roller chains based on the requirements of ISO 606
- All sprockets with pilot bores
- The material used is unalloyed tempered steel
- Special surface treatments are available on request

REQUEST DIRECTLY ONLINE NOW

<https://www.iwis.com/en-en/products-services/sprocket-08b-3-10-teeth~p5601>

Useful information

CALCULATION PROGRAM

InduKet: the Chain Drive Calculation Program for Engineers.

[iwis.com/chaincalc](https://www.iwis.com/chaincalc)

CHAIN CALCULATION

The right drive solution for your challenge.

chaindrive@iwis.com

SERVICES

ChainFinder, CAD data, iwis Chain Handbook and more.

[iwis.com/services](https://www.iwis.com/services)