



Hollow pin chain HB50,8-1 Series HB50,8 - ELITE

Part no.: 81024788

Packaging Unit: 5m

Brand: ELITE

Model: HB50,8

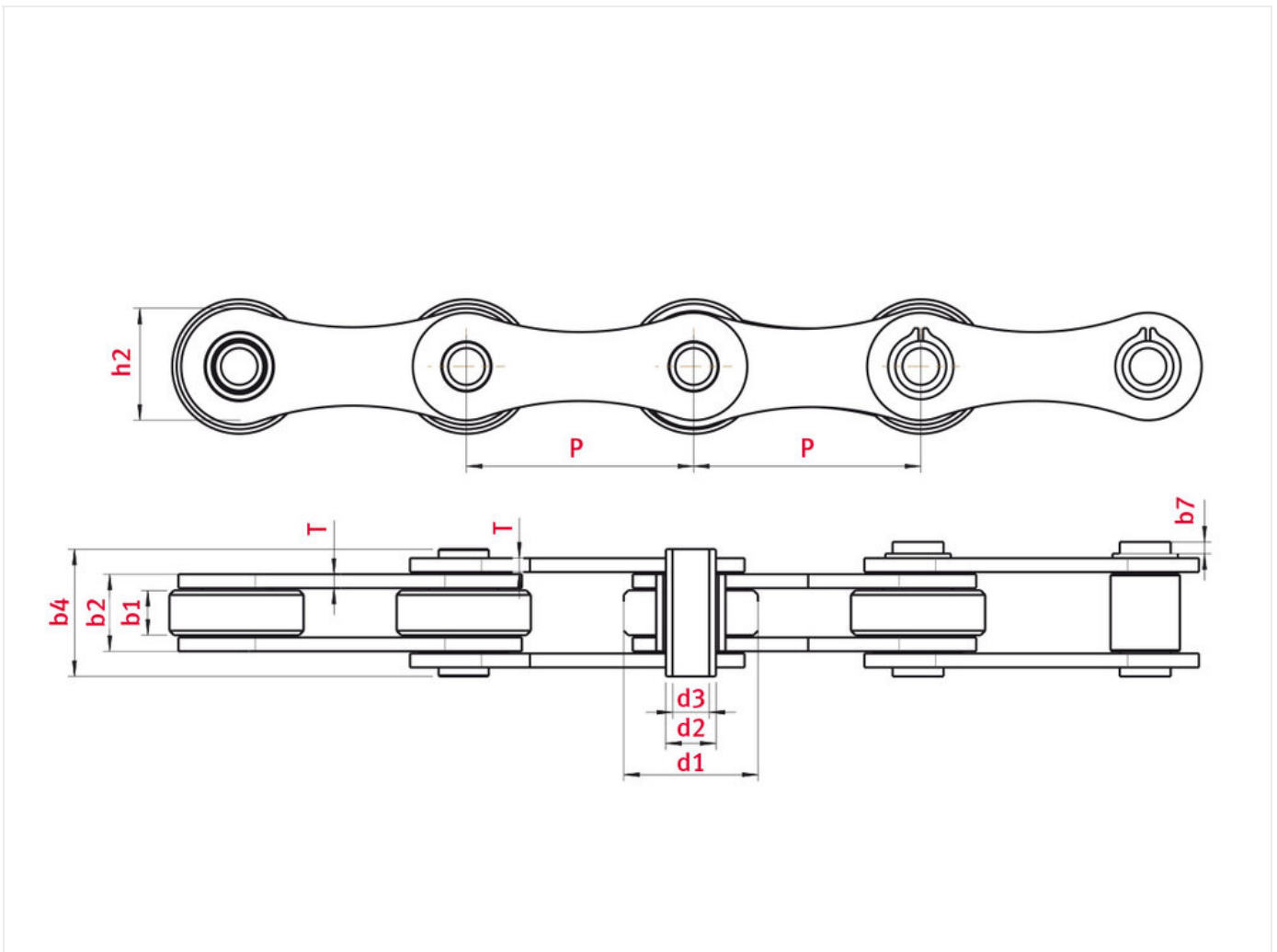

Technical data

ROLLER CHAIN	HB50,8
Pitch p (mm)	50,8
Width between inner plates b1 min. (mm)	10,5
Roller diameter d1 max. (mm)	30

Product data

Pin diameter d2 max. (mm)	11,2
Pin length b4 max. (mm)	28,5
Hollow pin inner diameter d6 min. (mm)	8,2
Maximum pin length of connecting link b4+b7 (mm)	29,6
Plate thickness Ti/To (mm)	3,1
Height inner plate h2 max. (mm) (JWIS: g)	26
Min. tensile strength ISO/DIN FU (kN)	42
Weight per meter (kg)	1,6

Product Information

Hollow pin chains from Series HB50.8 are used in many shuttle conveyor applications, especially in bakeries. A frequently recurring problem for plant suppliers and users alike are oil splashes and/or zinc abrasion resulting from sprocket tooth wear, which in turn cause serious contamination of the conveyor system.

iwis can now offer a further development of the existing hollow pin chains characterised by its longer service life and, above all, its better abrasion resistance. The better abrasion resistance of the newly developed HB50.8 ZPKDD version is achieved primarily through its optimised plastic slide bearing. In addition, thrust washers mounted between the inner and outer plates prevent undesirable tooth abrasion.

ELITE Highlights

- Many versions available from stock
- Versions with seamless bushes and hollow pins
- Available in steel, zinc-plated version and stainless steel
- On request, pair-matched chains are supplied to guarantee ideal parallel running
- Plastic rollers made of wear-resistant POM
- Blue-coloured plastic rollers available on request
- Chains with wax lubricant iwiDUR available on request

Applications

- Conveyor technology
- Food processing industry
- Measurement and testing technology
- Feeding and automation technology

REQUEST DIRECTLY ONLINE NOW

<https://www.iwis.com/en-en/products-services/hollow-pin-chain-hb50-8-1-series-hb50-8-elite~p3538>

Useful information

CALCULATION PROGRAM

InduKet: the Chain Drive Calculation Program for Engineers.

[iwis.com/chaincalc](https://www.iwis.com/chaincalc)

CHAIN CALCULATION

The right drive solution for your challenge.

chaindrive@iwis.com

SERVICES

ChainFinder, CAD data, iwis Chain Handbook and more.

[iwis.com/services](https://www.iwis.com/services)