



Roller chain 28B-1 - ELITE

Part no.: 81013162

Packaging Unit: 5m

Brand: ELITE

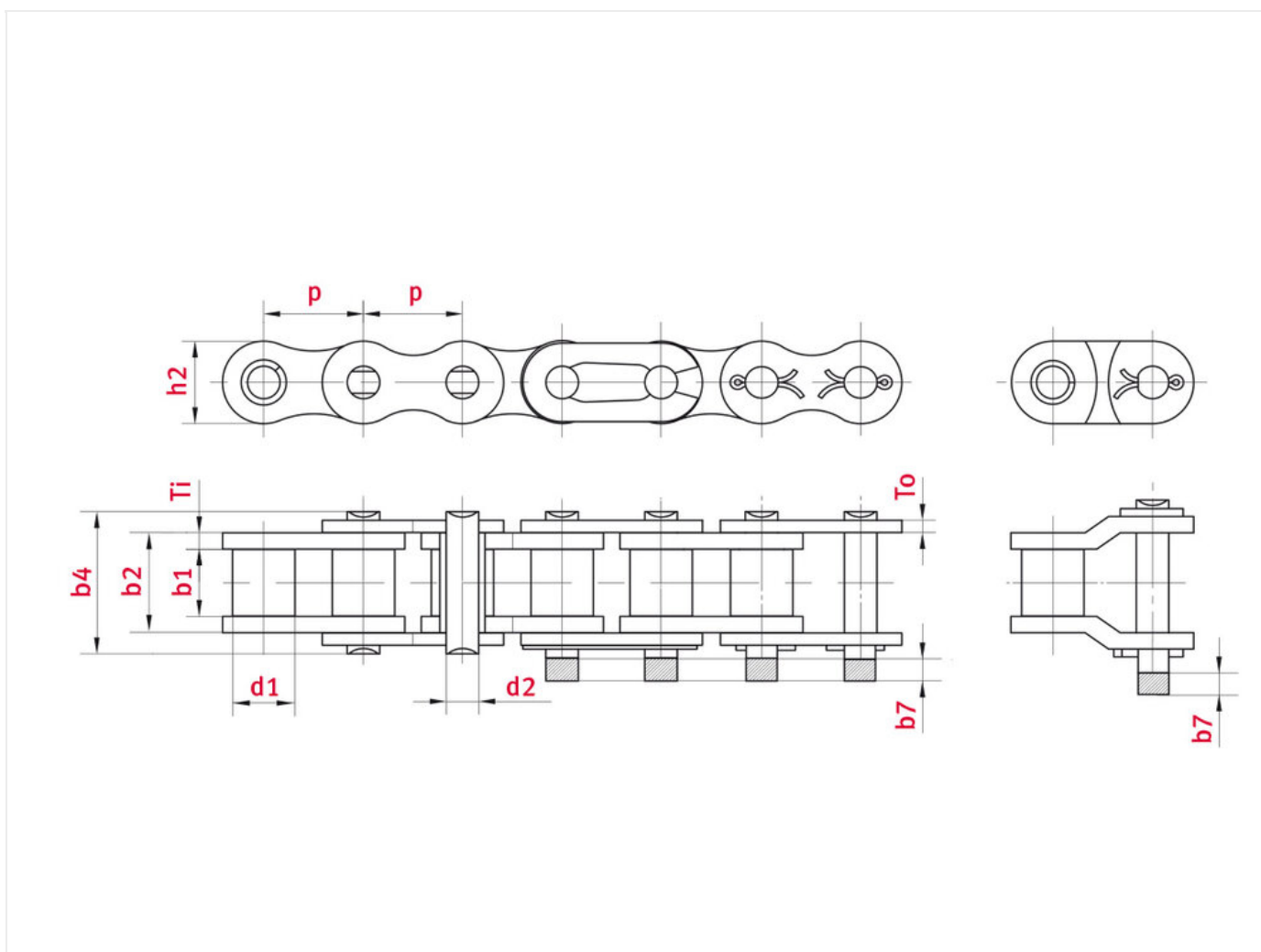

Technical data

ROLLER CHAIN	28B
Pitch p (mm)	44,45
Width between inner plates b1 min. (mm)	30,99
Roller diameter d1 max. (mm)	27,94

Pin diameter d2 max. (mm)	15,9
Pin length b4 max. (mm)	65,1
Max. add. length of connecting link b7 max. (mm)	7,4
Total width inner link b2 max. (mm)	46,58
Plate thickness Ti/To (mm)	7,50/6,00
Height inner plate h2 max. (mm) (JWIS: g)	37,08
Min. tensile strength ISO/DIN FU (kN)	200
Avg. tensile strength FB (kN)	215,6
Weight per meter (kg)	8,5
Bearing surface f (cm ²)	7,4

Product Information

ELITE roller chains have a high wear resistance and significantly higher fatigue strength than the standard requires. The right choice for industrial applications: robust and reliable. All ELITE transmission roller chains are highly pre-tensioned and treated with our special additive chain oil eliDUR+, a high-tech initial lubricant. Non-drip eliDUR+ offers not only the added advantage of improved running characteristics, but also provides better corrosion protection.

ELITE highlights:

- Approx. 40% higher breaking strength is applied to pre-stretch our chains by 10% more than required by standard ISO 606
- Initial lubrication with eliDUR+ ensures extremely high wear resistance
- Low run-in elongation
- Tensile strength on average 20% higher than required by standard ISO 606
- ELITE pins have a smooth, extra- hard surface for increased wear resistance
- Operating temperature range with eliDUR+ standard lubrication: -5 °C to +70 °C
- All versions also available in coated form
- If required, we can deliver your chains ready-made to the desired length
- Special lubricants for low temperatures down to -30 °C or high temperature applications up to +250 °C available on request
- On request, iwis delivers chains pair-matched or set-matched and marked

Applications

- Warehouse technology, materials-handling industry
- Conveyor technology
- Assembly and industrial handling systems
- Wood processing industry

- Mechanical engineering and systems construction
- Glass, ceramic and building material industry
- Environmental technology, Recycling

REQUEST DIRECTLY ONLINE NOW

<https://www.iwis.com/en-en/products-services/roller-chain-28b-1-elite~p3228>

Useful information

CALCULATION PROGRAM

InduKet: the Chain Drive Calculation Program for Engineers.

[iwis.com/chaincalc](https://www.iwis.com/chaincalc)

CHAIN CALCULATION

The right drive solution for your challenge.

chaindrive@iwis.com

SERVICES

ChainFinder, CAD data, iwis Chain Handbook and more.

[iwis.com/services](https://www.iwis.com/services)